

Dreux 44 5x4

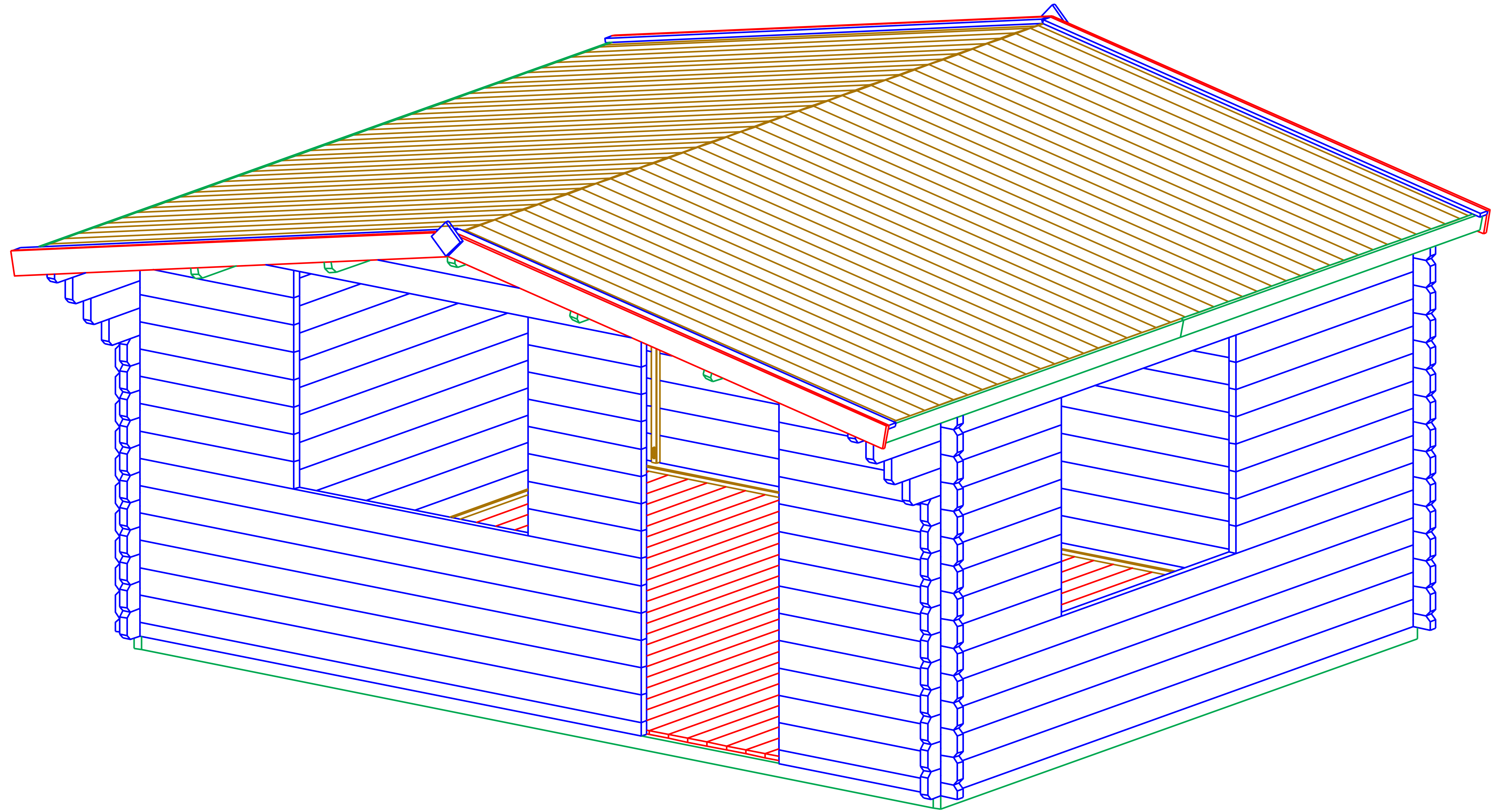

Dreux 44 5x4

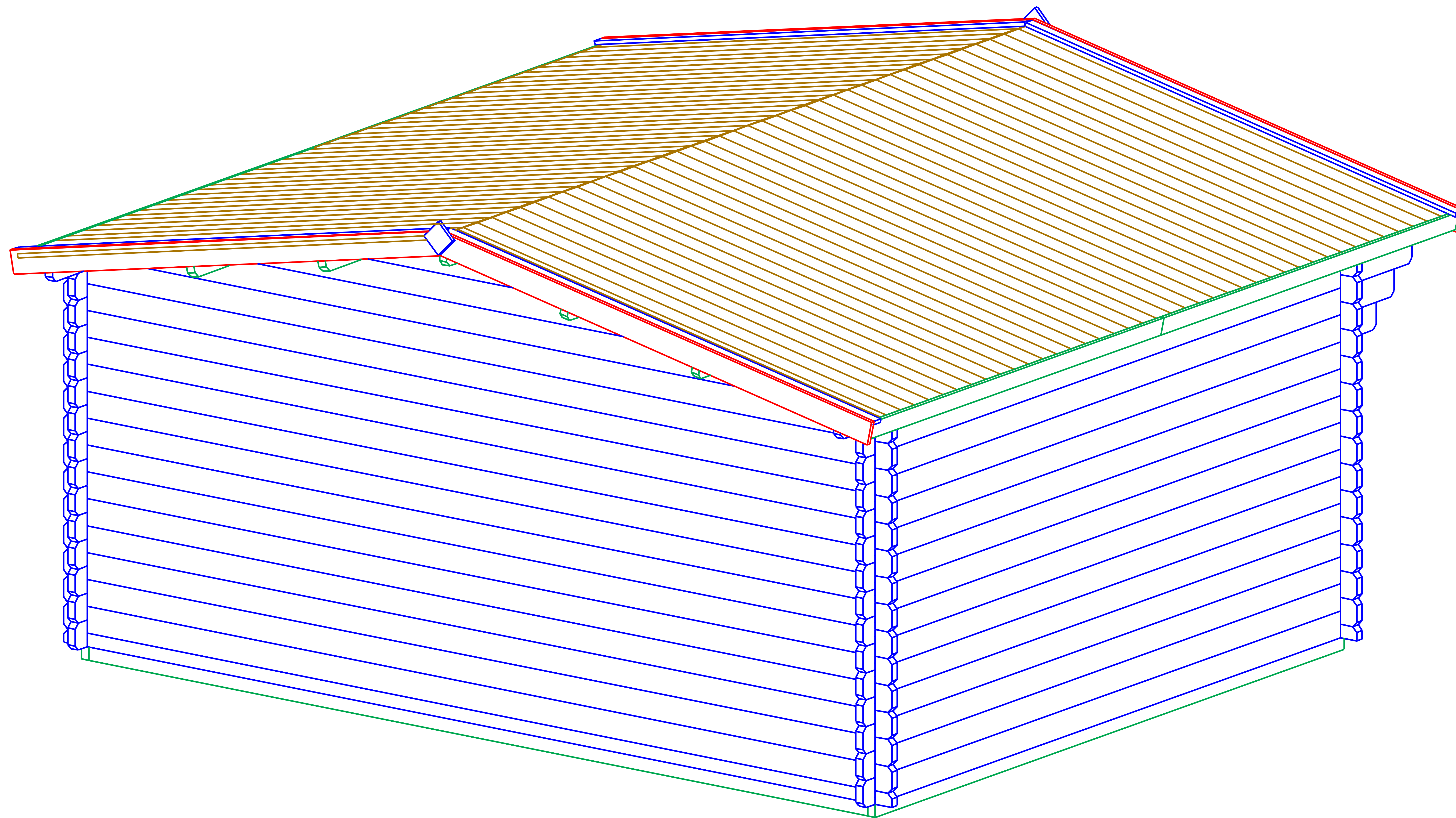

Dreux 44 5x4

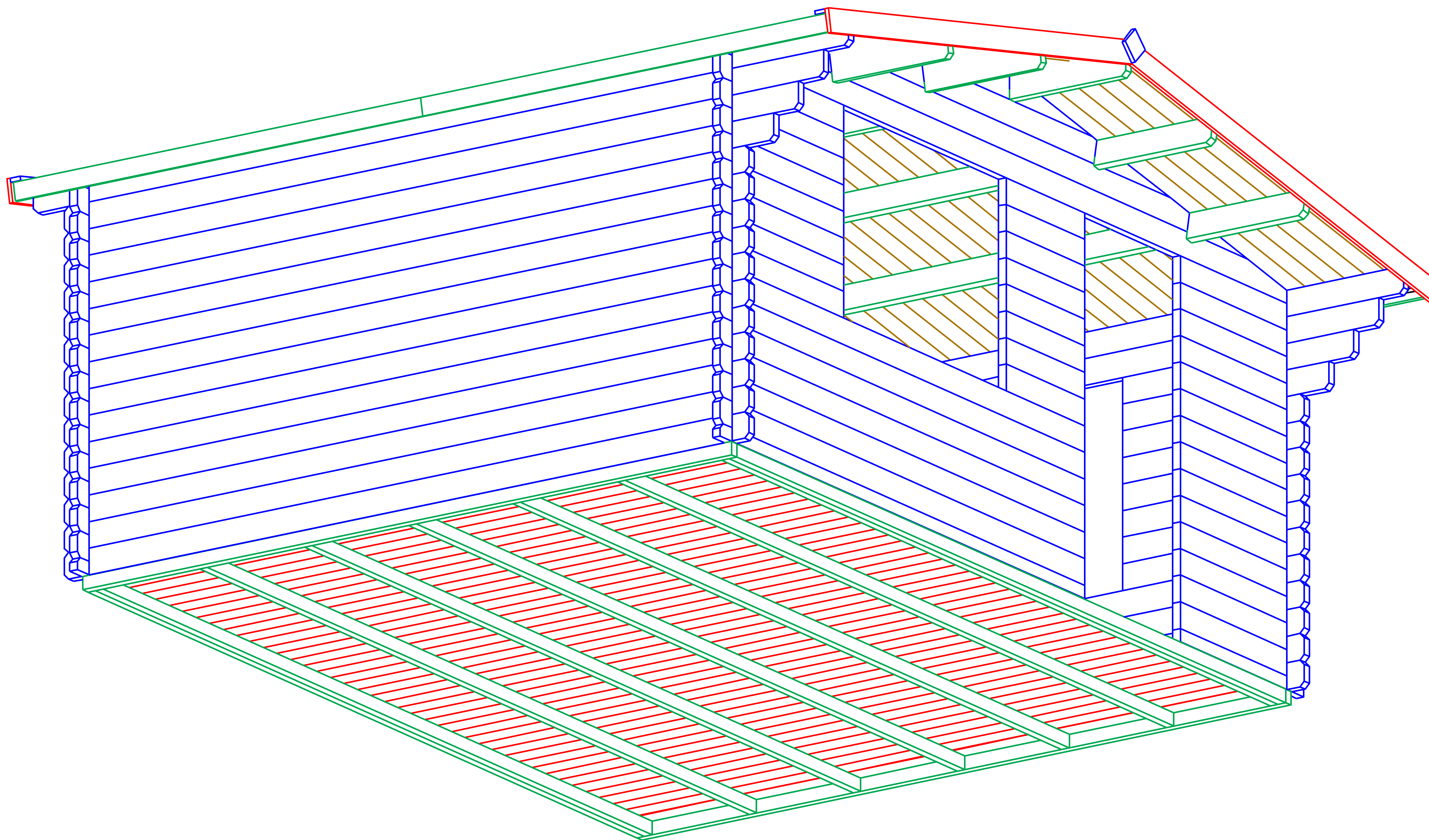

Dreux 44 5x4
Plan

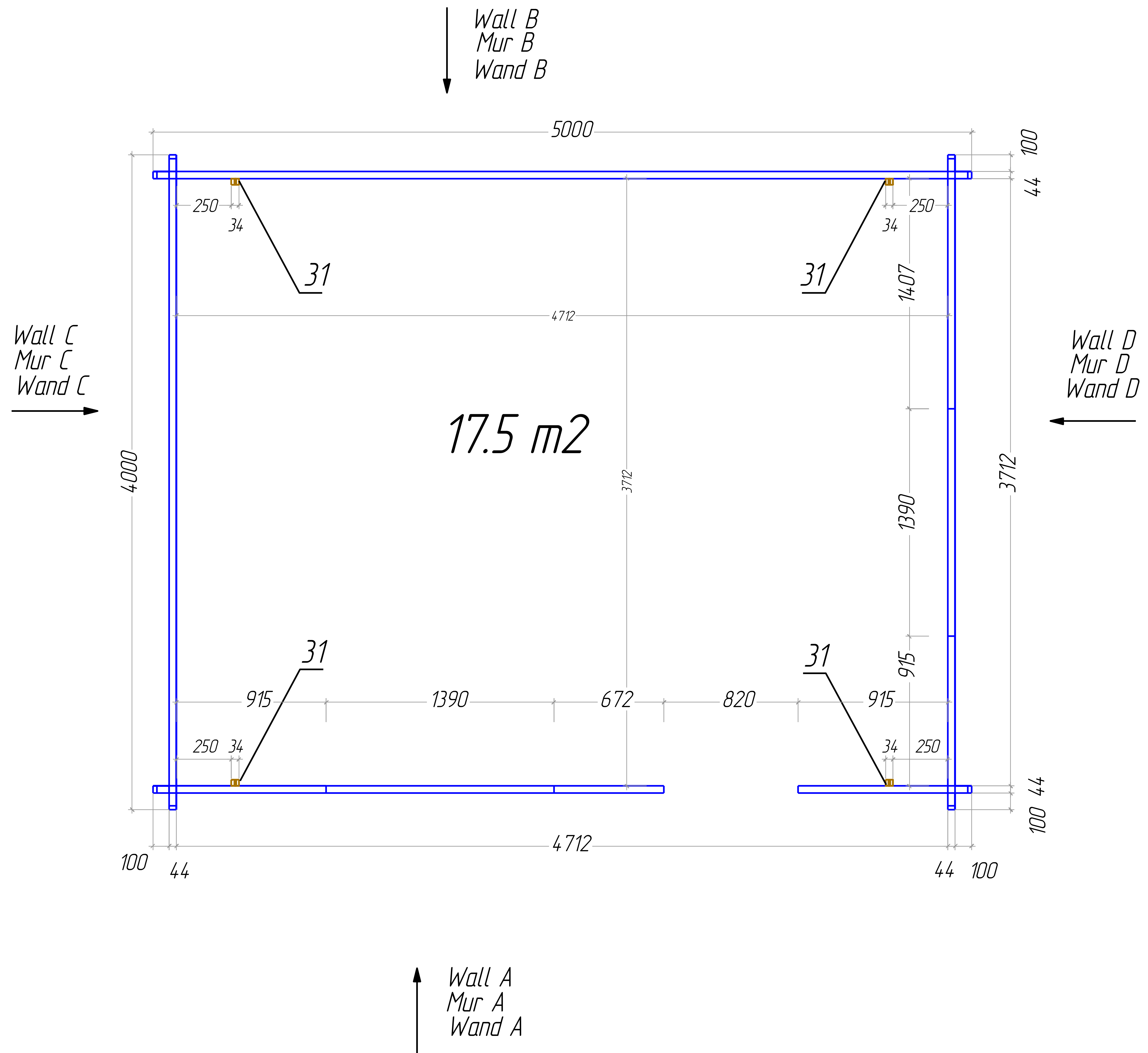

Dreux 44 5x4

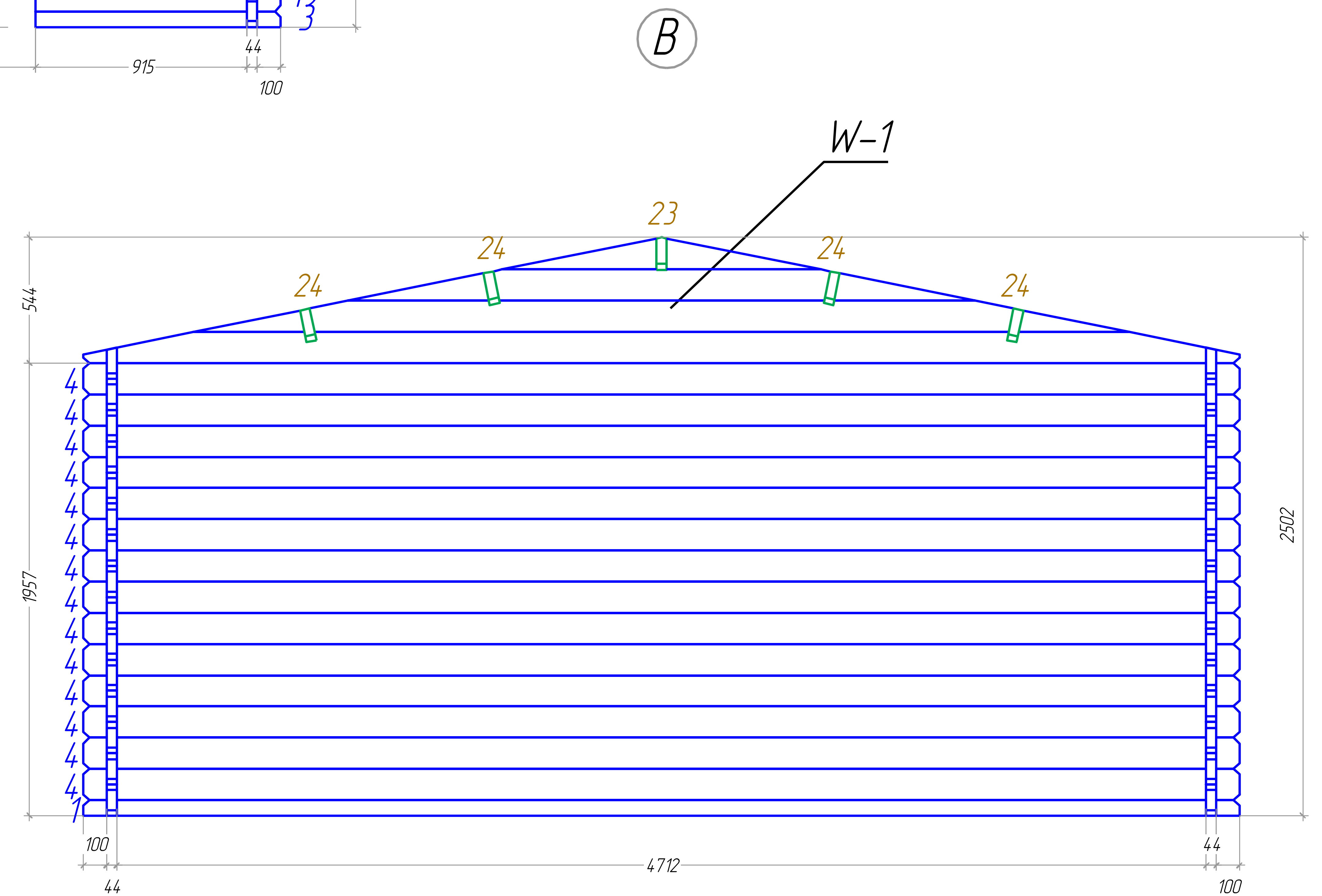
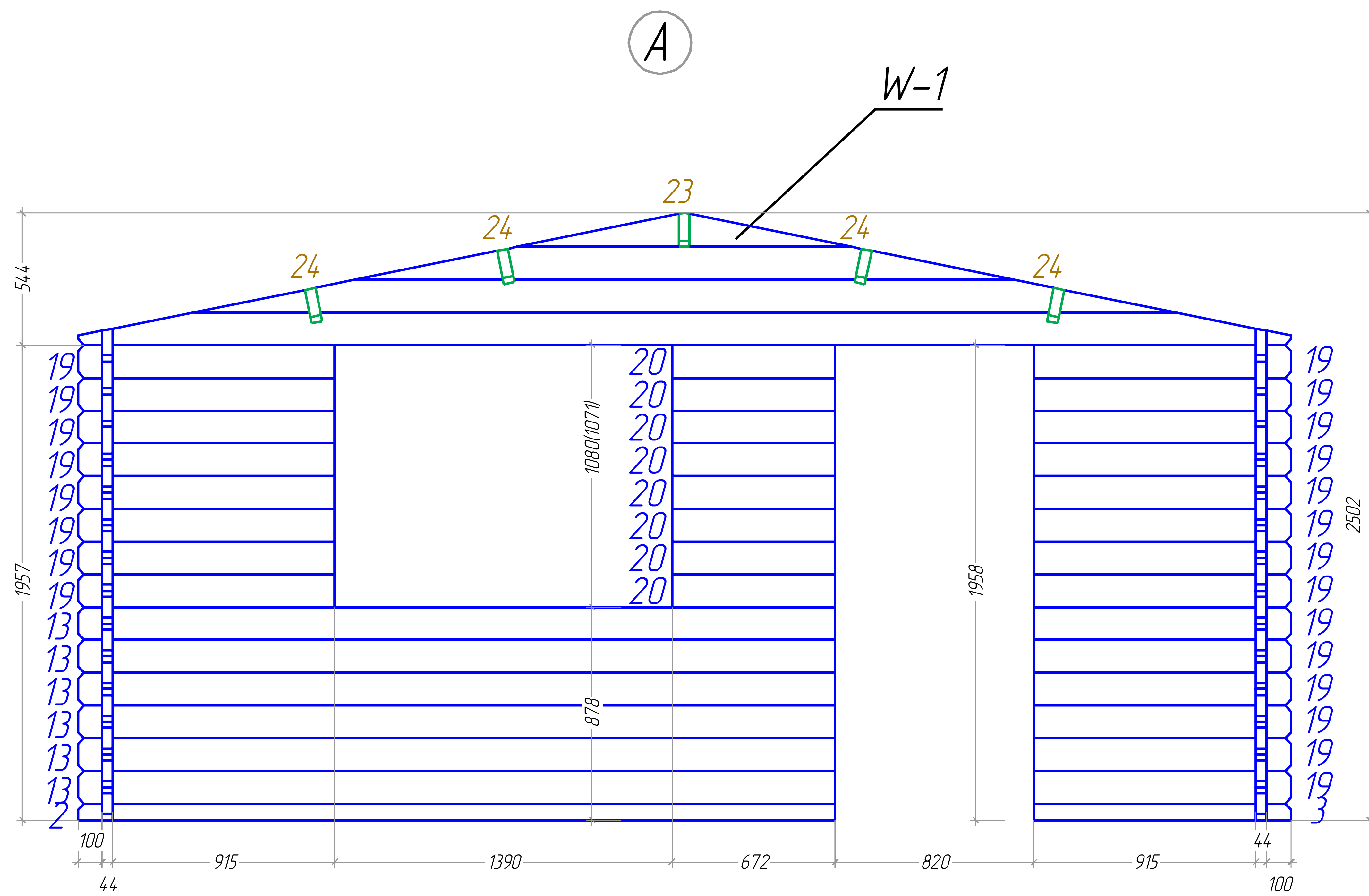

Dreux 44 5x4

C

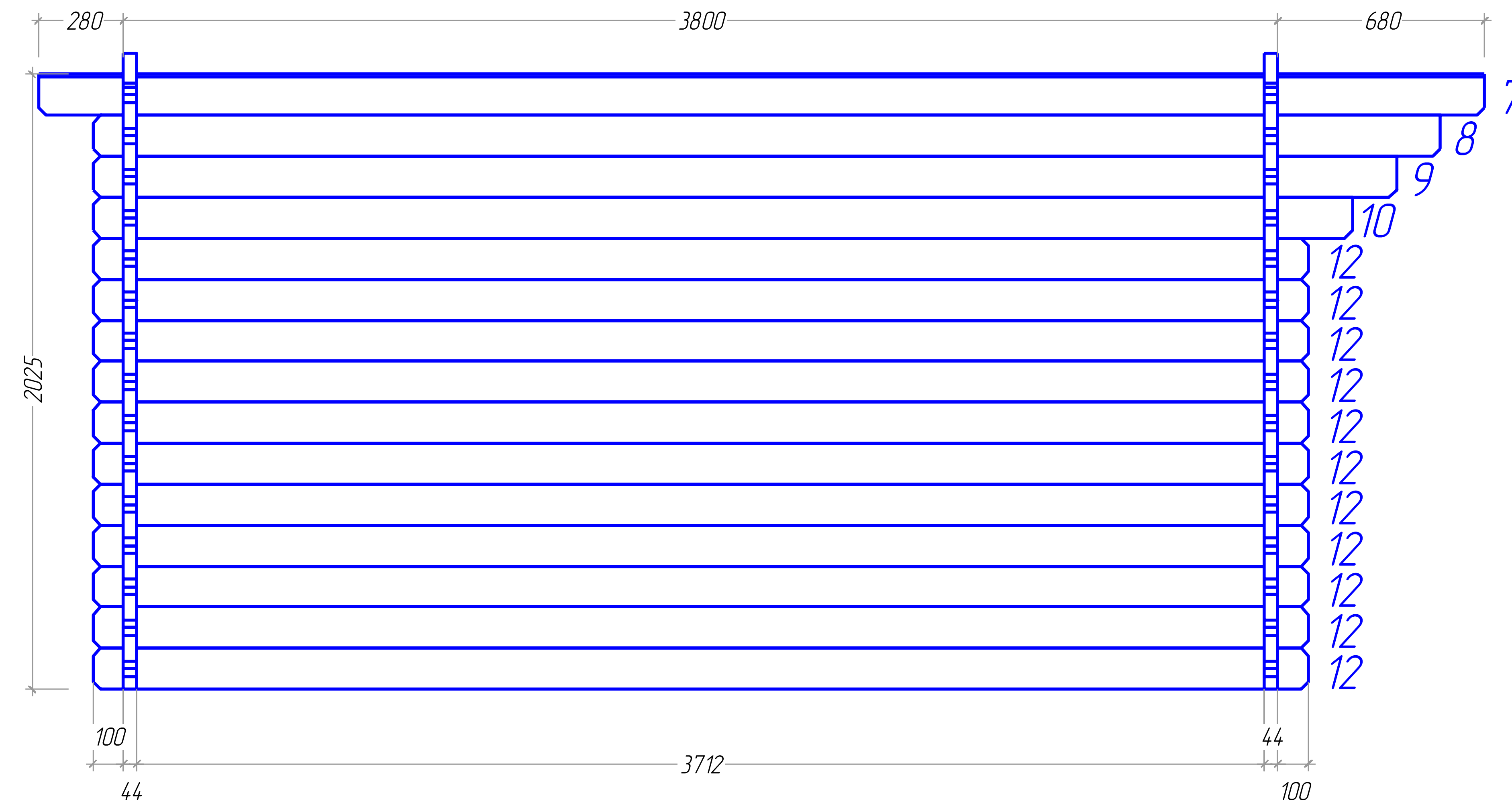

D

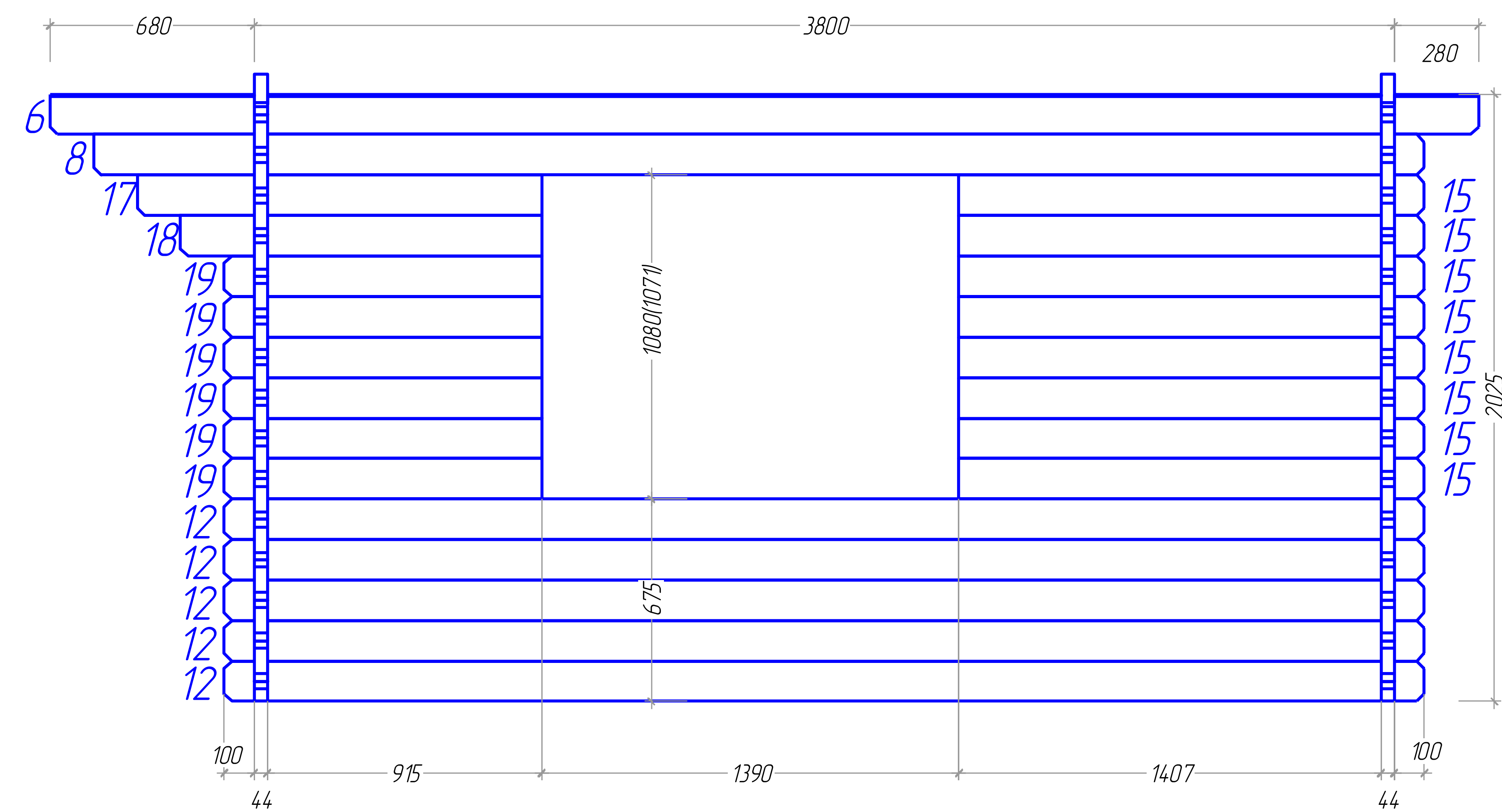

Dreux 44 5x4

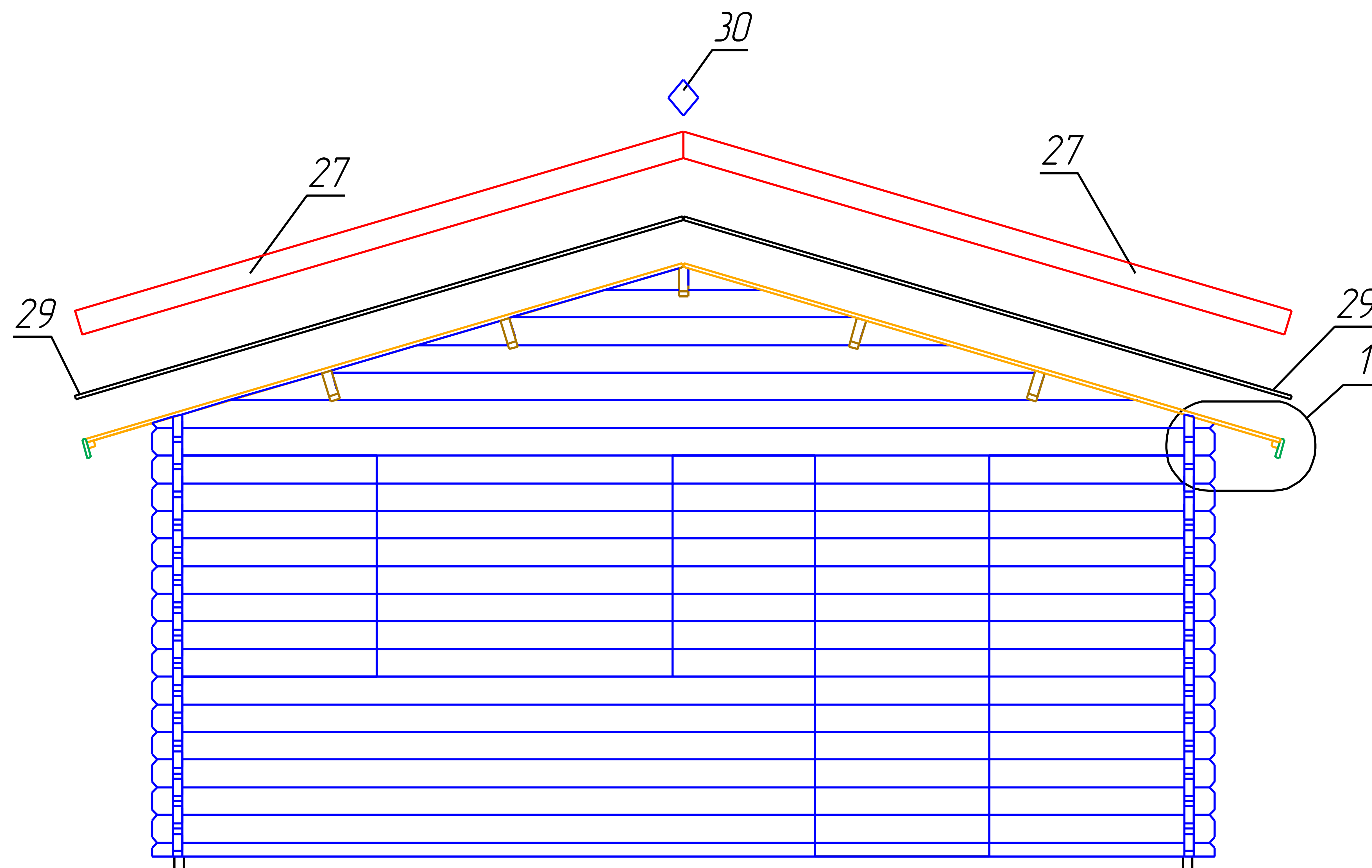

$\frac{1}{M 1:5}$

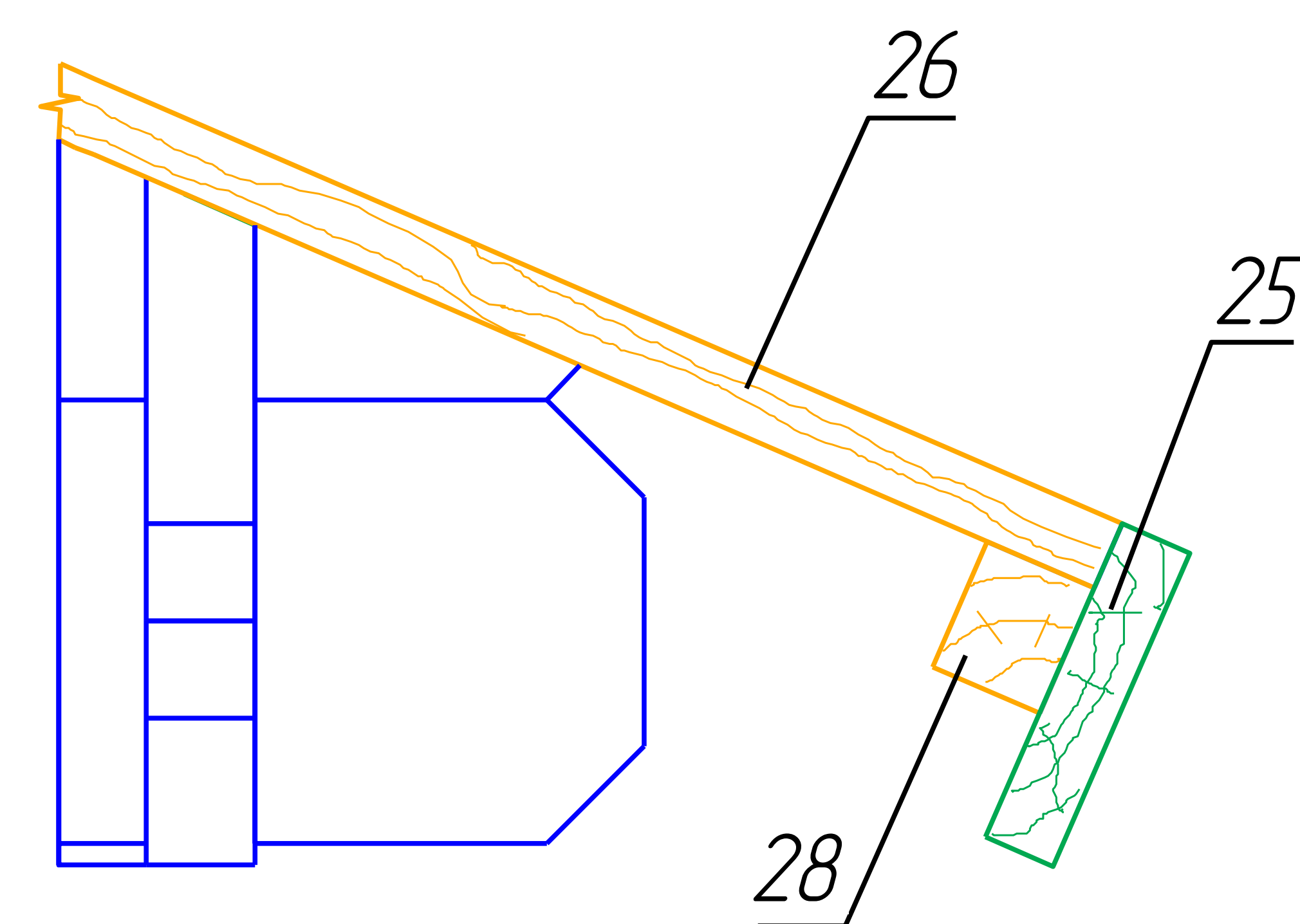

Dreux 44 5x4

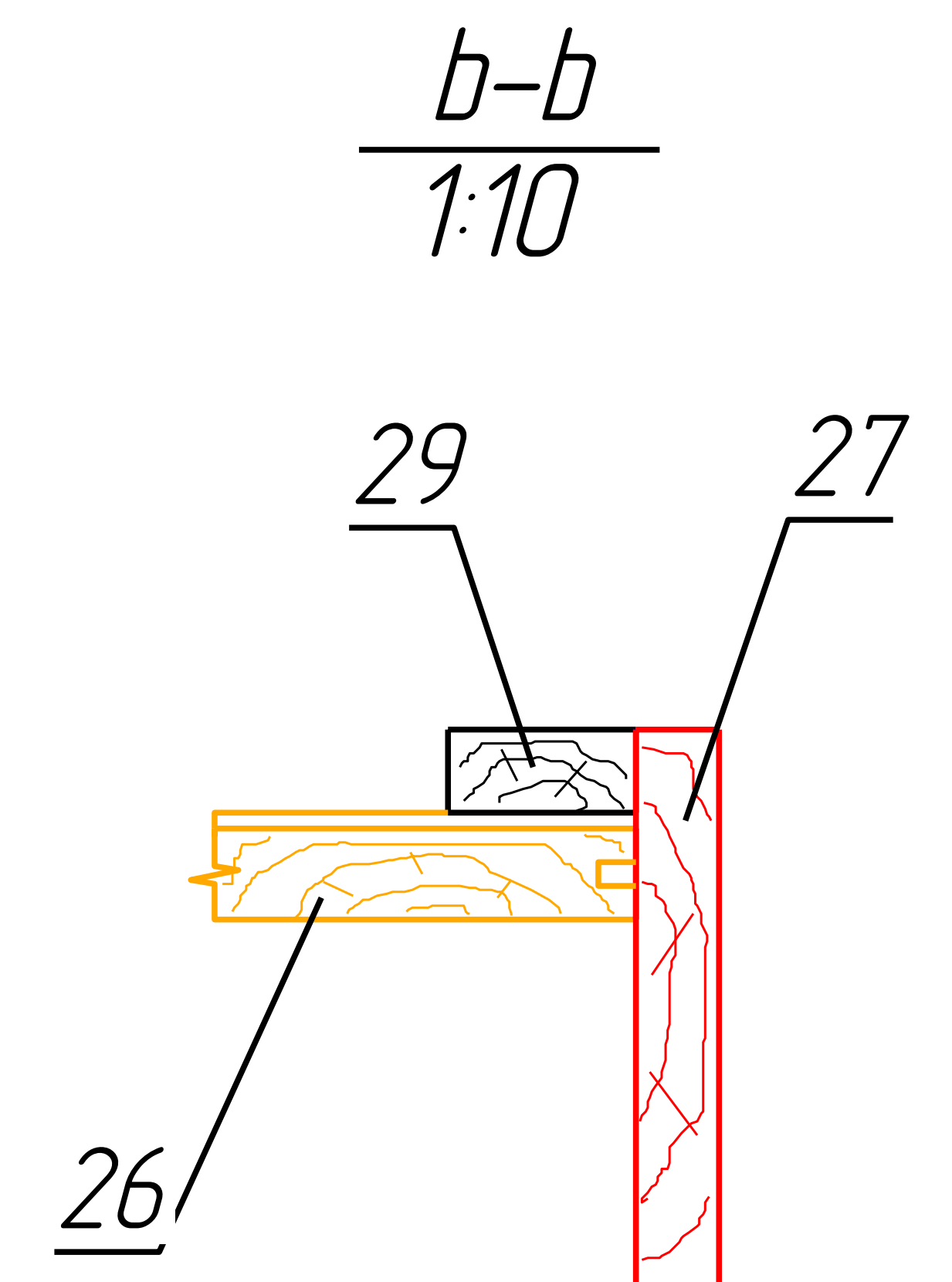
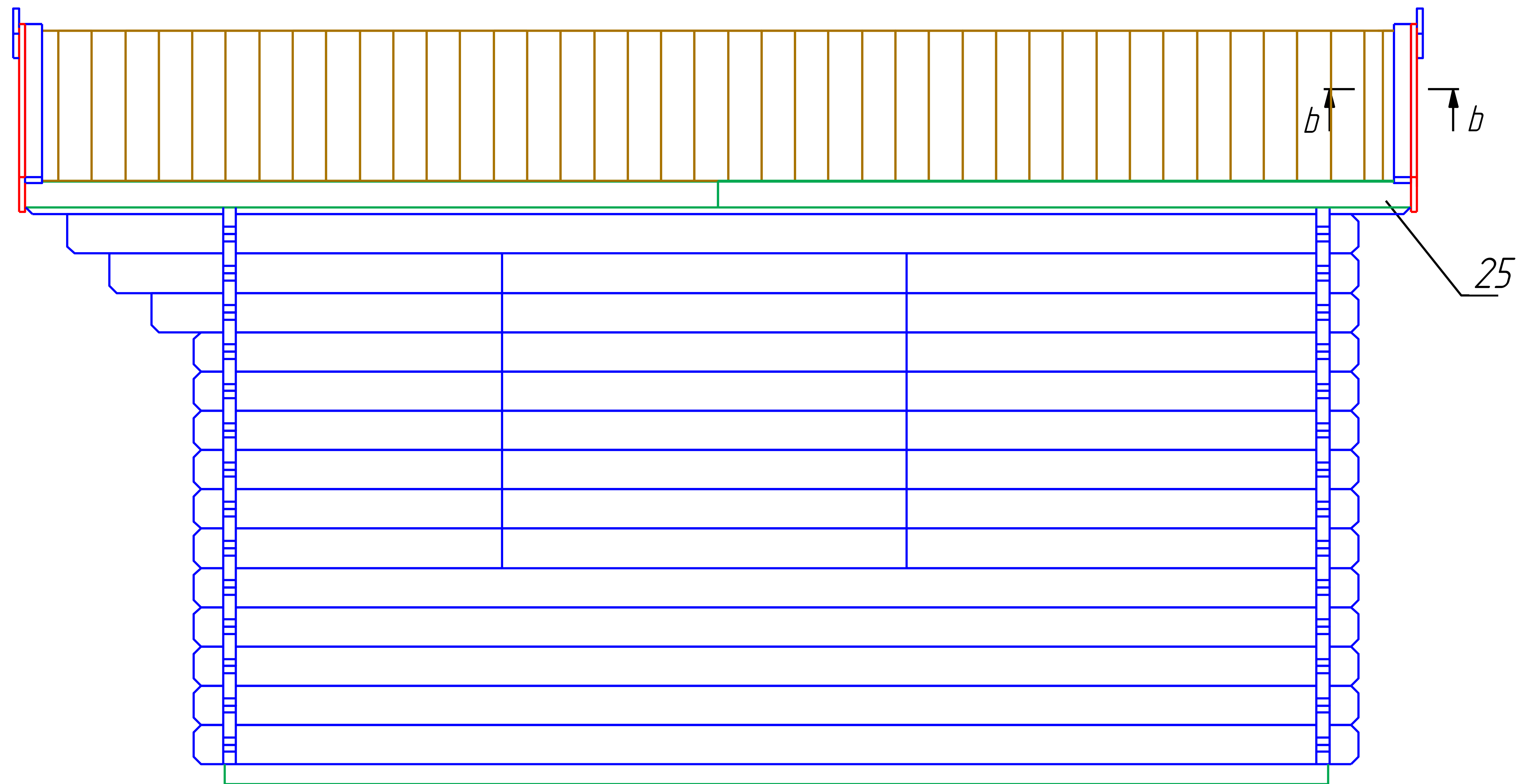

Dreux 44 5x4

Plan of the roof board

Plan der Dachbretter

Le plan des planches du toit

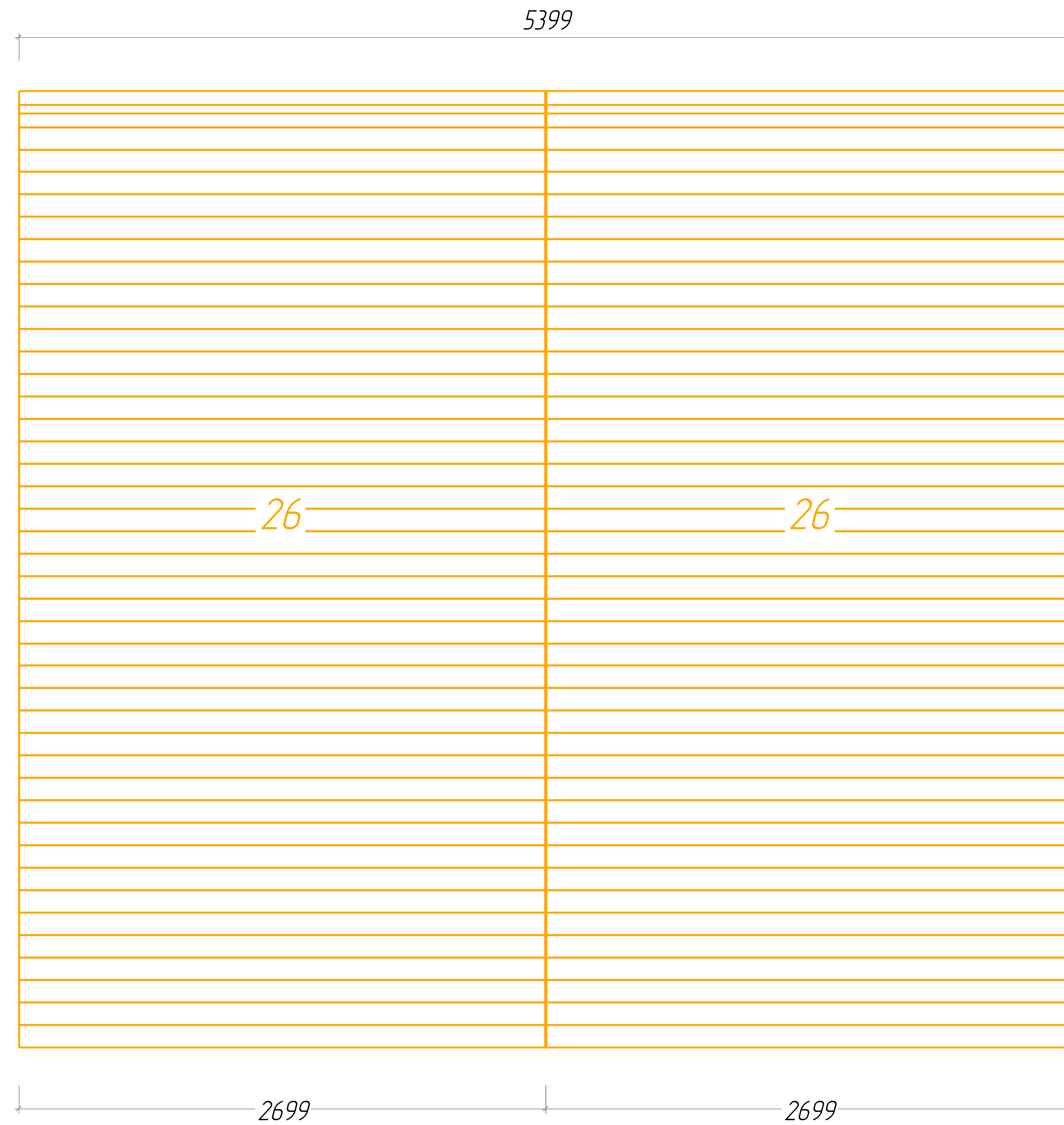

Dreux 44 5x4

Boarding joist plan
Trumplan
Lambourde plan

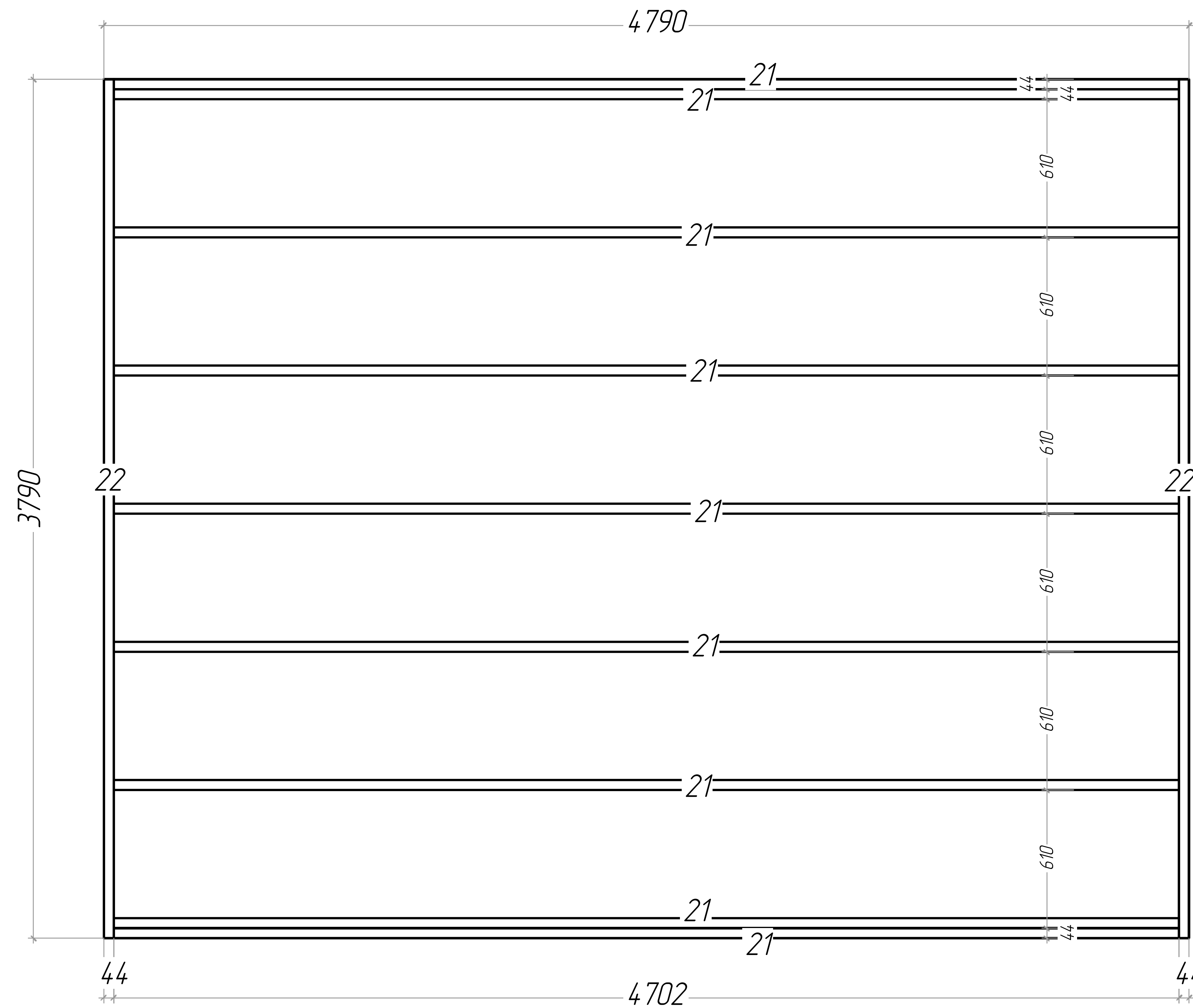





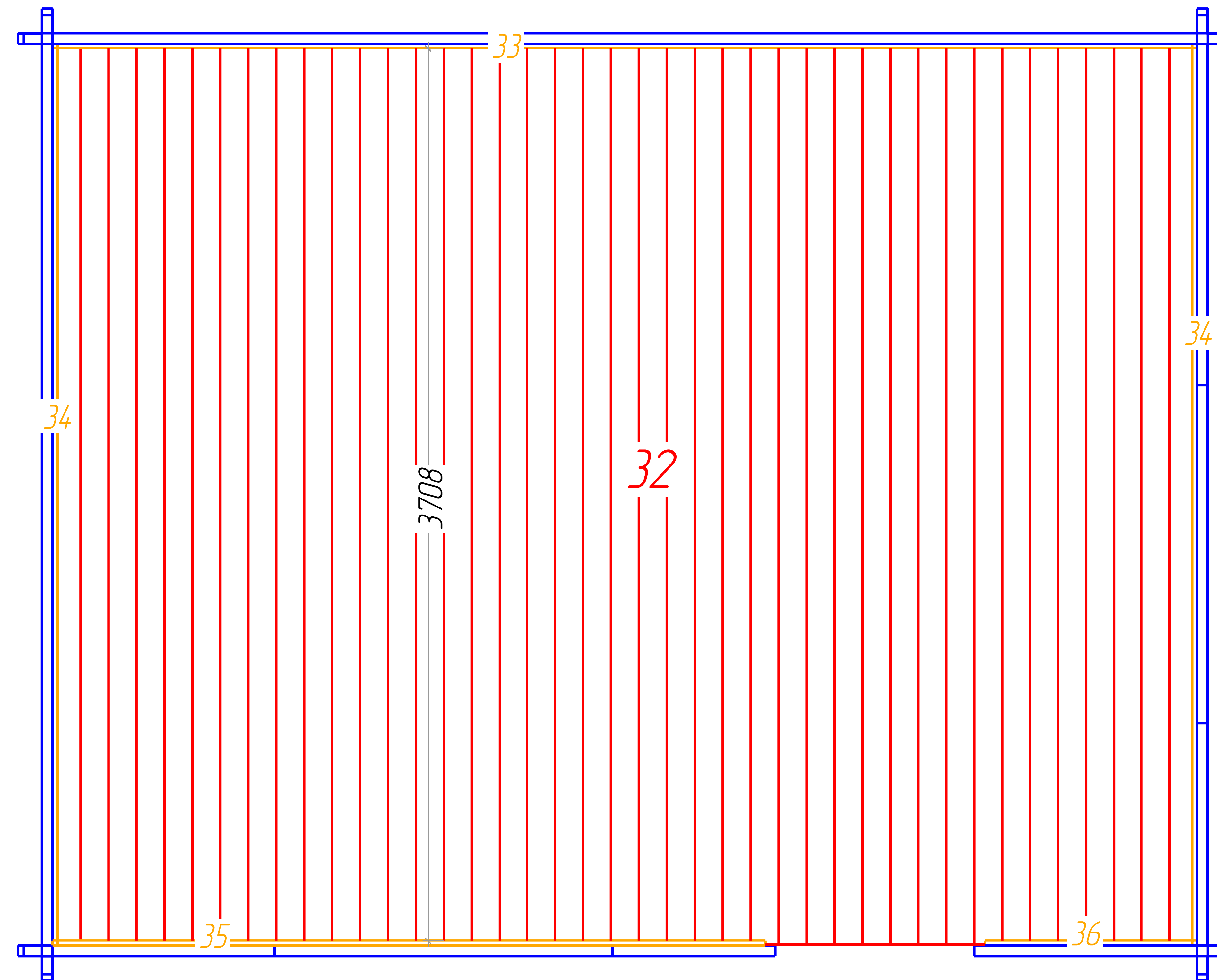

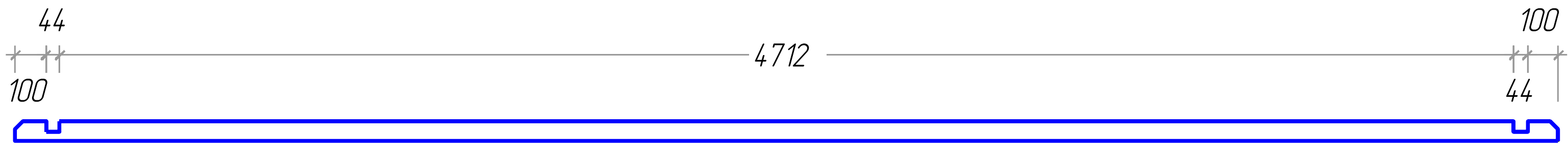
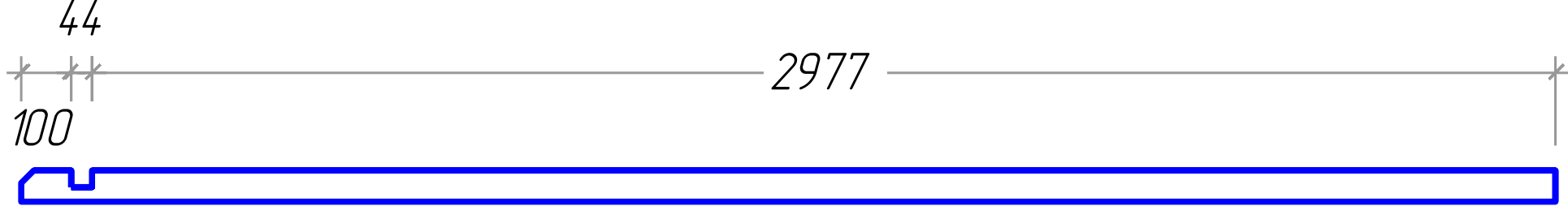
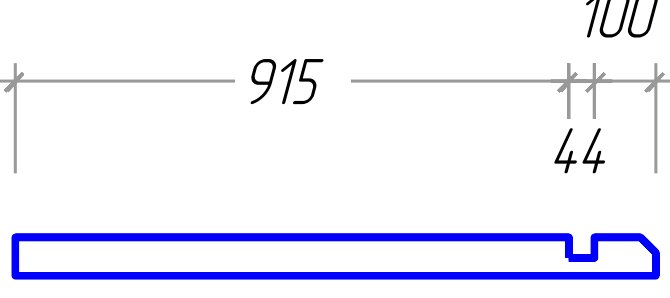
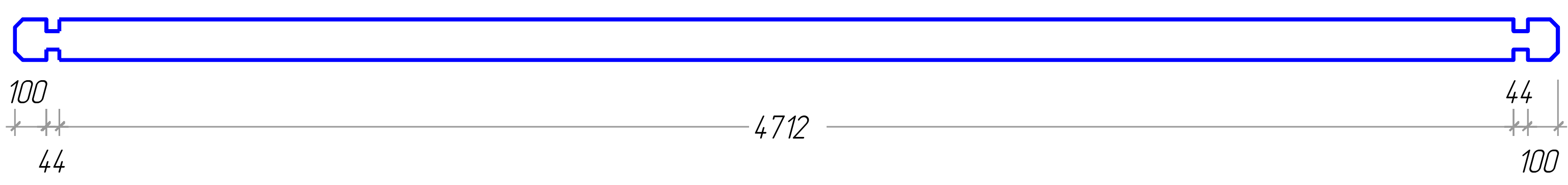
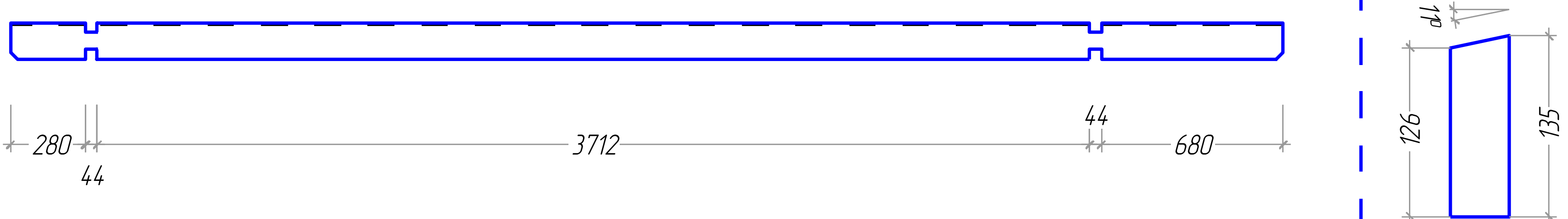
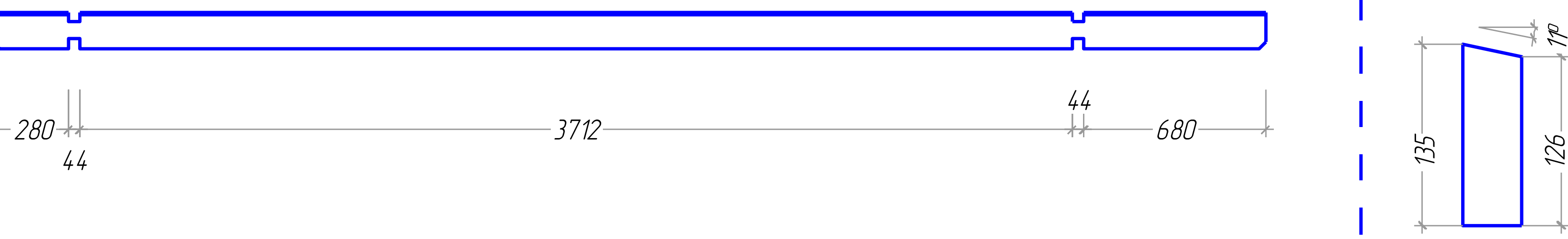
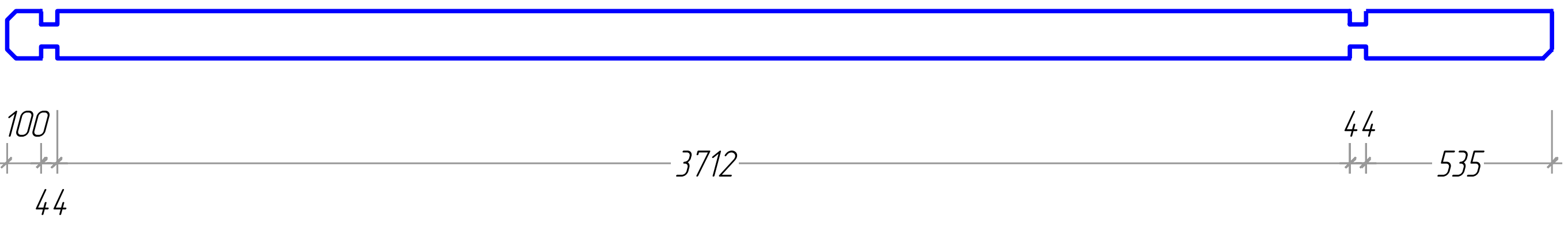
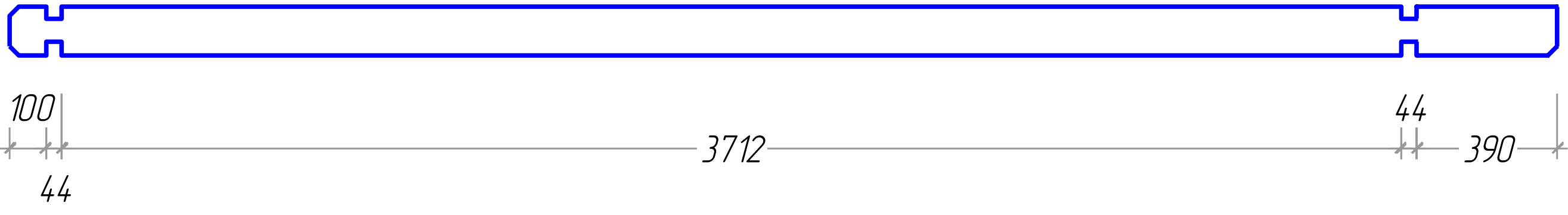
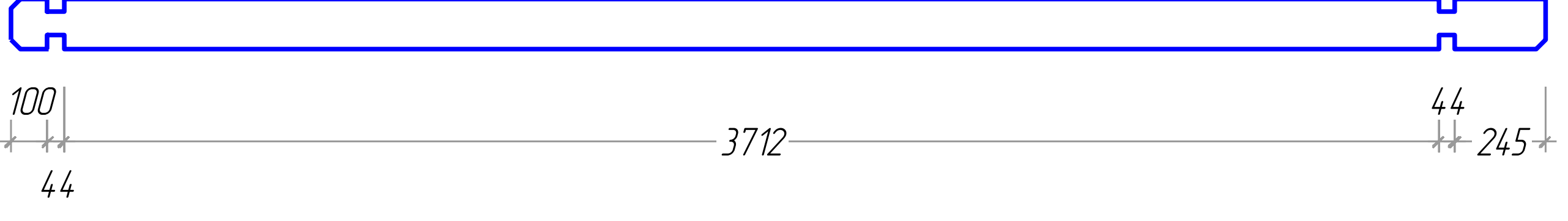
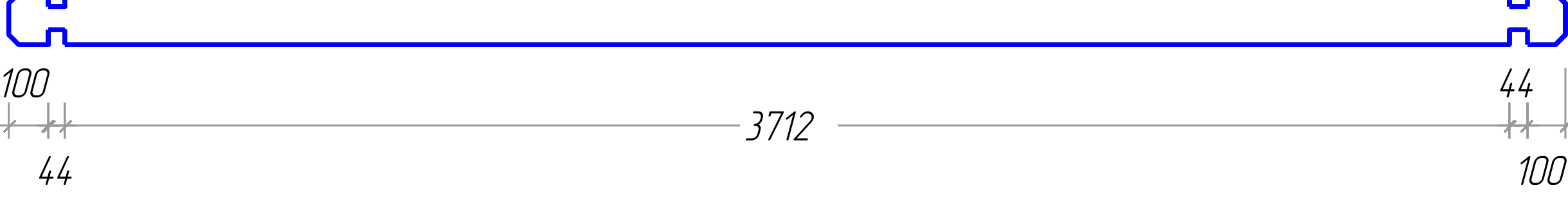
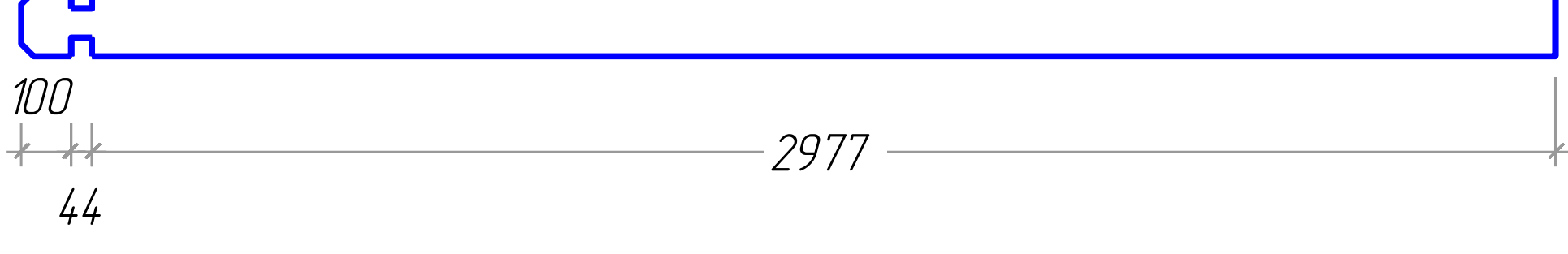
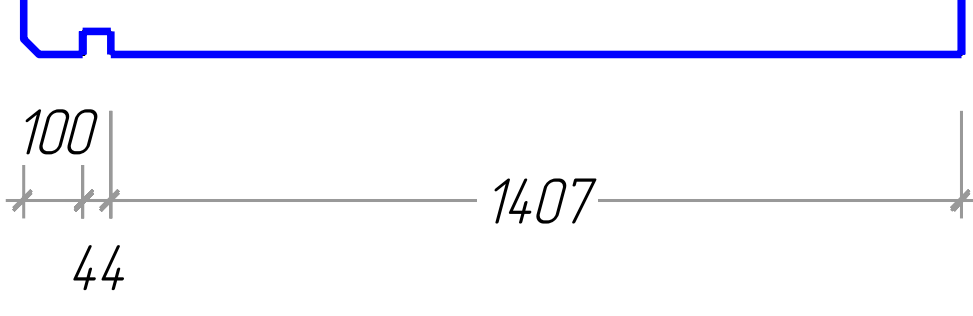
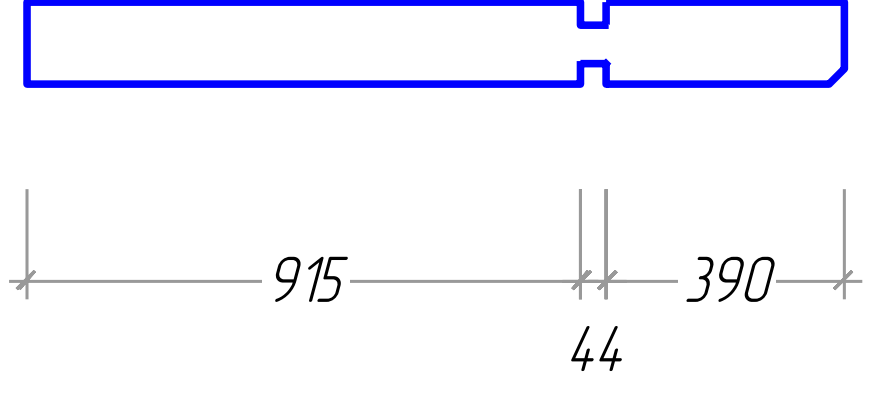

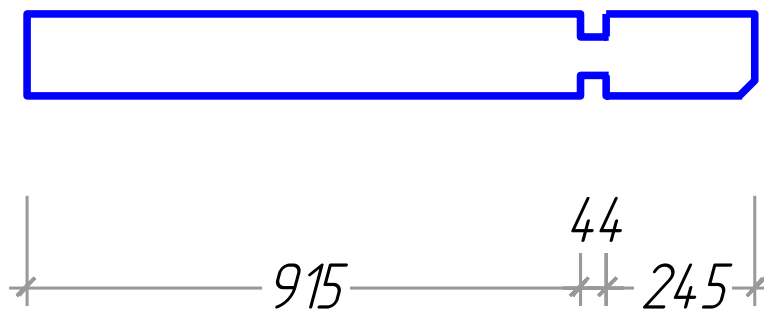
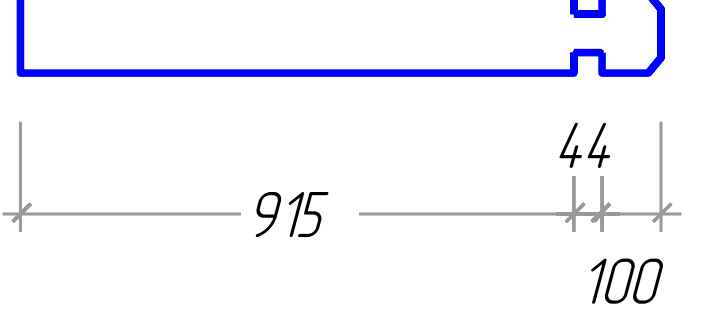
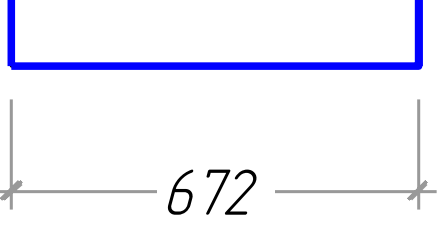

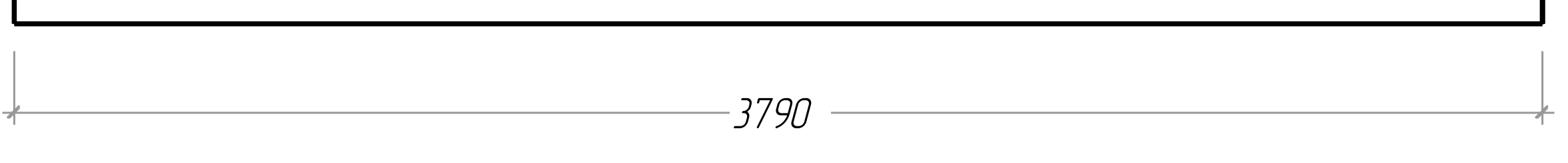

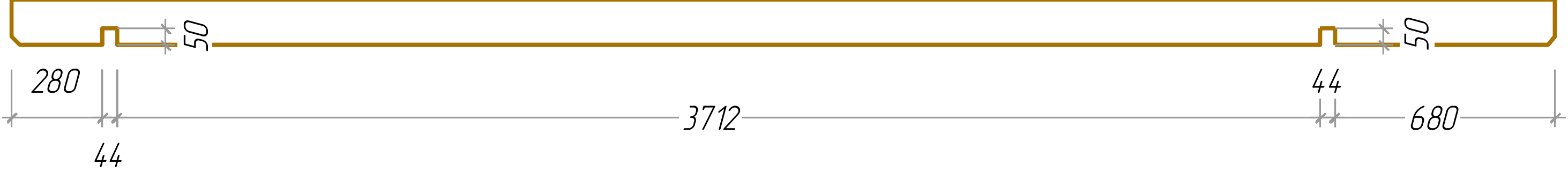
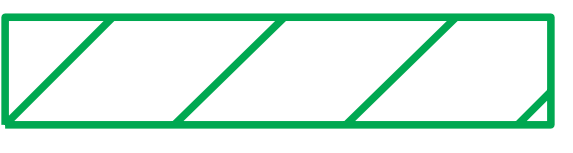
Dreux 44 5x4

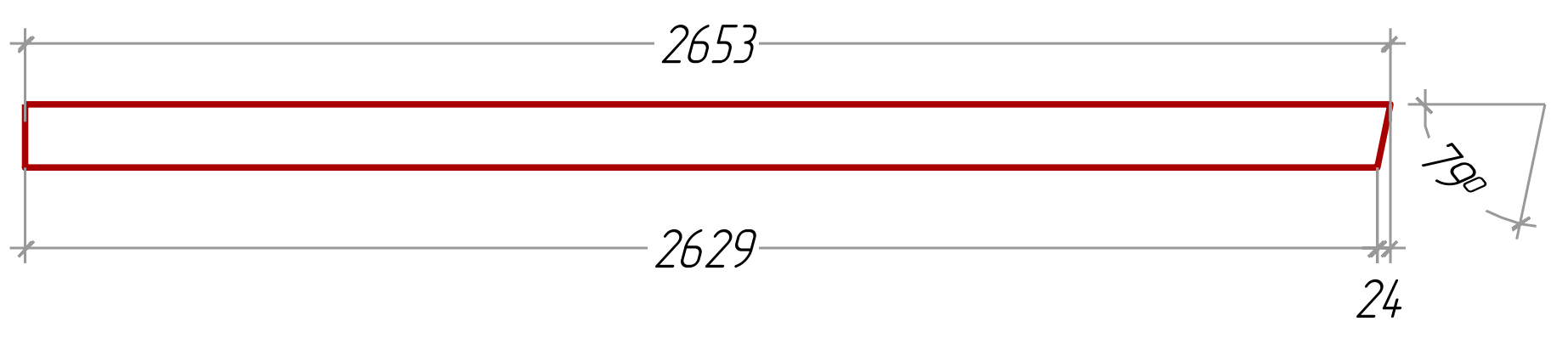
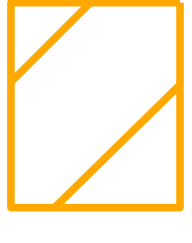
*Plan of the floor board
Plan der Furbodenbretter
Le plan des plaches du plancher*

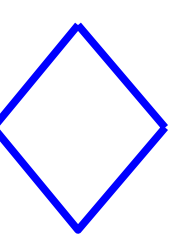

N°	Dreux 44 5x4	Nr.	Profile (mm)	Lenght (mm)
1		1	44x67,5	5000mm
2		1	44x67,5	3121mm
3		1	44x67,5	1059mm
4		14+1	44x135	5000mm
6		1	44x135	4760mm
7		1	44x135	4760mm
8		2	44x135	4435mm
9		1	44x135	4290mm
10		1	44x135	4145mm
12		16	44x135	4000mm
13		6	44x135	3121mm
15		8	44x135	1551mm
17		1	44x135	1349mm

Nº	Dreux 44 5x4	Nr.	Profile (mm)	Lenght (mm)
18		1	44x135	1204mm
19		28	44x135	1059mm
20		8	44x135	672mm
21	<i>Foundation Fundament Solive</i> 	9	44x68	4702mm
22	<i>Foundation Fundament Solive</i> 	2	44x68	3790mm
23	<i>Roof beam. Dachbalken. Panne</i> 	1	44x140	4760mm
24	<i>Roof beam. Dachbalken. Panne</i> 	4	44x140	4760mm
25	<i>Roof side boards Traufenbrett Planche de rive</i> 	4	18x90	2380mm
26	<i>Roof boards. Dachbretter Volige</i> 	84+1	20x115	2603mm
27	<i>Fascia board Giebelblende Planch de rive facade</i> 	4	20x120	2653mm
28	<i>Roof edge reinforcement Traufleisteu Tasseau</i> 	6	28x34	1586mm
29	<i>Roofing felt fillet Giebelabschlussbrett Latte de finition couverture</i> 	4	20x58	2649mm
30	<i>Diamond Raute Diamant</i> 	2	T. 20	120mm

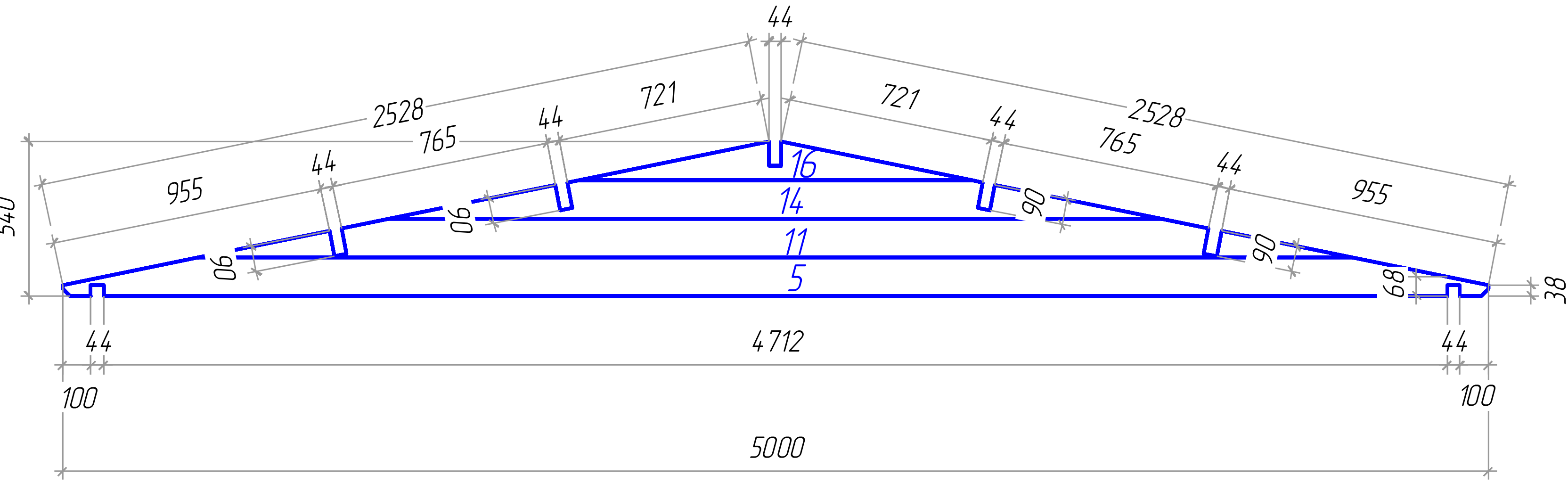
Nº	Dreux 44 5x4	Nr.	Profile (mm)	Lenght (mm)
31	<i>Storm protection</i> 	4	28x34	1900mm
32	<i>Floor boards</i> <i>Fu ssboden</i> <i>Lame de plancher</i> 	41+1	20x115	3708mm
33		1	20x18	4712mm
34		2		3712mm
35		1		2934mm
36		1		872mm
W-1		2		
	<i>Door</i> <i>Tur</i> <i>La porte</i> 820x1958 mm	1		
	<i>Window</i> <i>Fenetre</i> <i>Fenster</i> 1390x1080 mm	2		

Storm protection

